

FlexX DUO 5-4596

FEATURE HIGHLIGHTS

- Frameless
- Fits 42 in. (1066 mm) - 45 in. (1142 mm) finished **Opening**
- Up to 3 in. (76mm) in width adjustment
- Single pivot door with two (2) panels
- Self-closing pivot hinges
- Chrome, brushed stainless, satin gold and satin black hardware finished available.
- Different handle options available
- U-channel and wall profile for out of plumb adjustment
- Reversible installation

SPECIFICATIONS

FlexX Duo / MODEL NUMBER: SW0138-4596

DIMENSIONS

- Fits 42 in. (1066mm) - 45 in. (1142 mm) wide x 96 1/2 in.(2451 mm) height
- Opening clearance 28 1/8 in.(714mm) min - 30 1/8 in. (765mm) max.
- Up to 3 in. (76 mm) in width adjustment
- Up to 1/2 in. (12 mm) out-of-plumb adjustment

GLASS

- 5/16 in. (8 mm) clear glass door and hinged fixed panel and 3/8 in. (10 mm) clear glass for inline panel
- ANSI certified tempered glass

HARDWARE

- Chrome finish (see options)
- Solid stainless steel glass mount self-closing hinges
- Aluminum threshold, U-channel and wall profile
- Fully frameless glass design

STANDARD FEATURES

- Single pivot door with two (2) panels
- Reversible for right or left door installation
- Polycarbonate water proof seal strips



FlexX DUO 5-4596

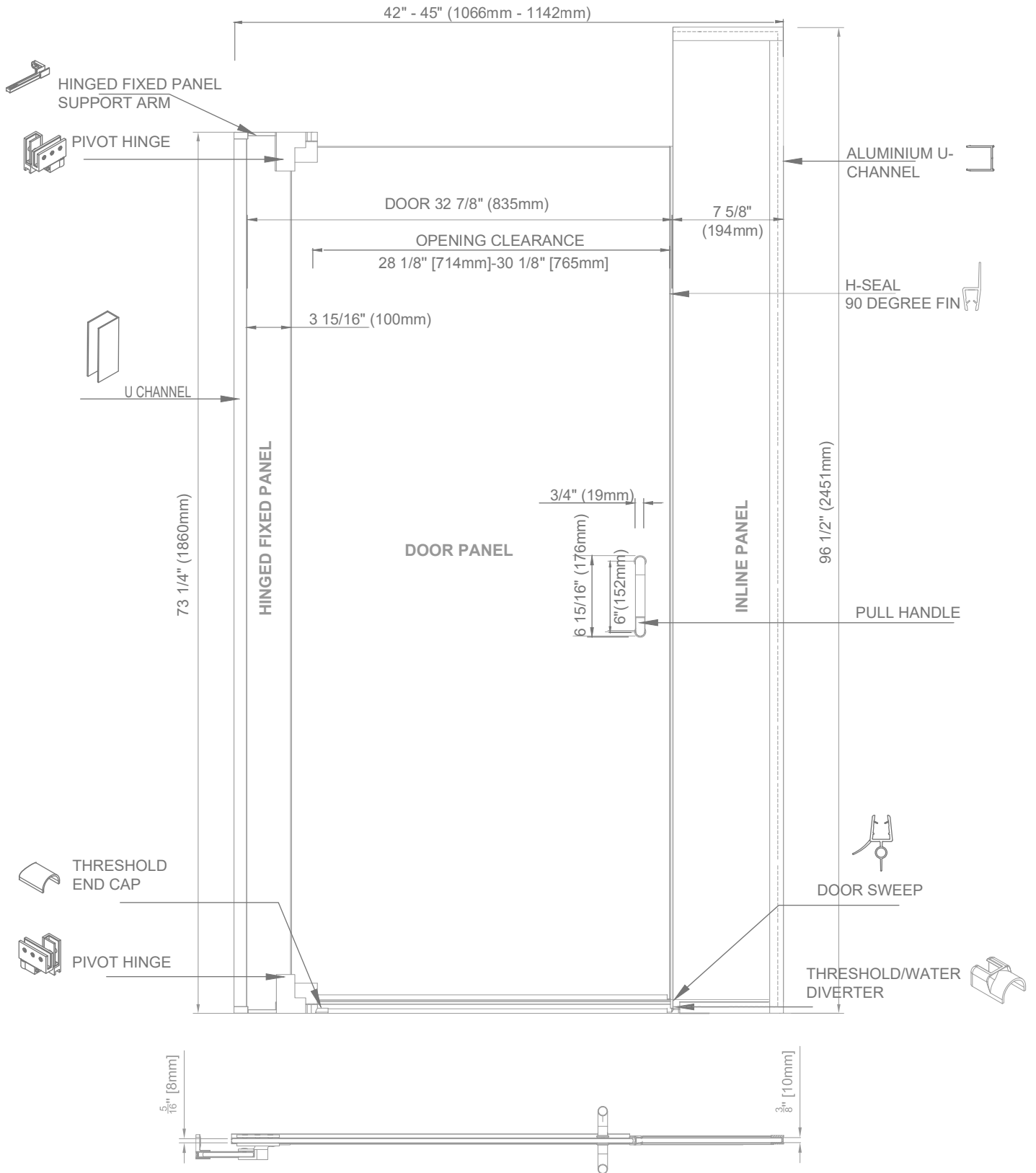

PARTS SPECIFICATIONS



HINGED FIXED PANEL SUPPORT ARM

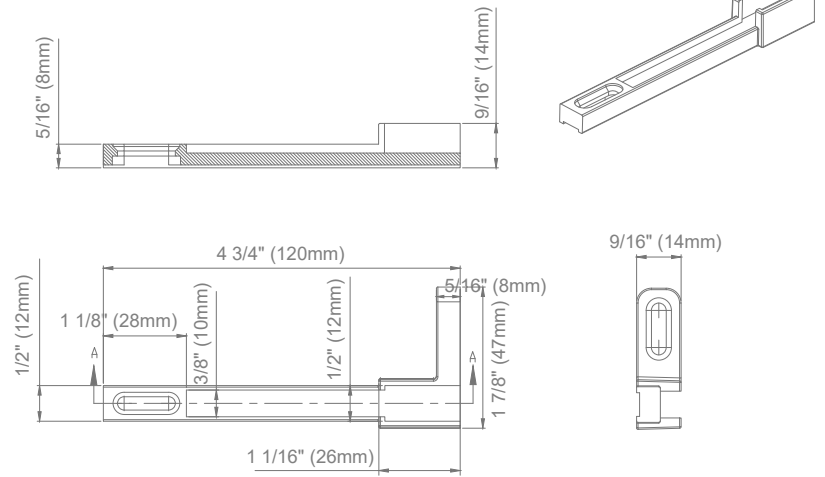

SCREW COVER

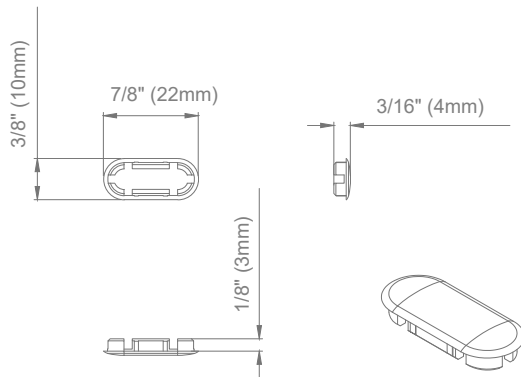

PIVOT HINGE

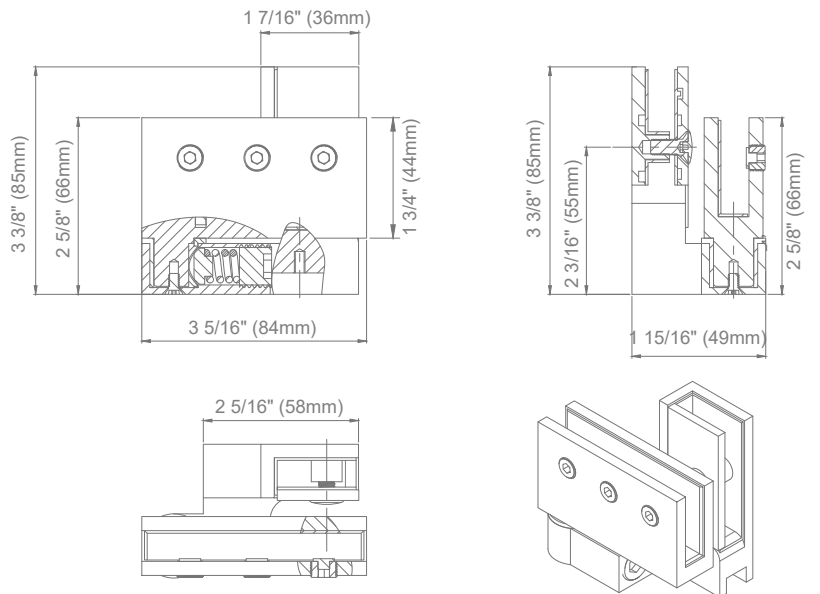

PARTS SPECIFICATIONS

THRESHOLD/WATER DIVERTER

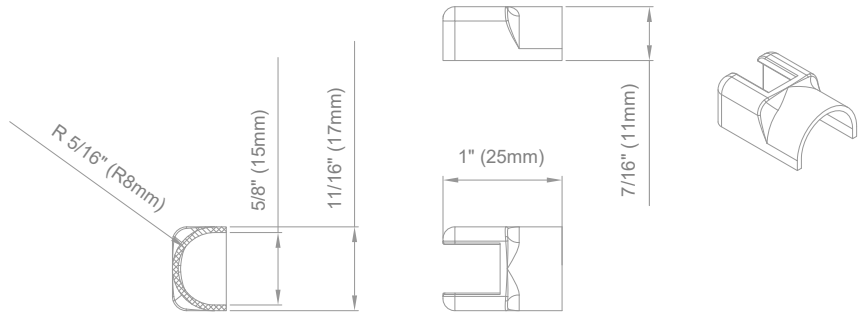

U-CHANNEL

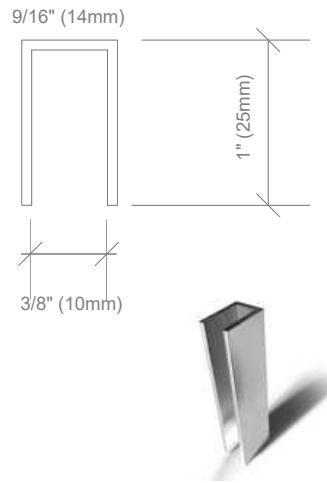

H-SEAL WITH 90 DEGREE VINYL FIN

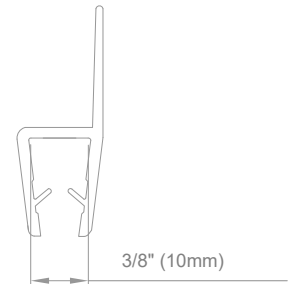

PULL HANDLE

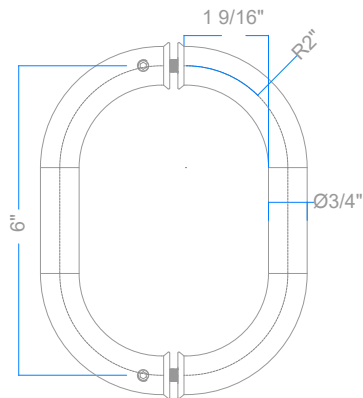

DOOR SWEEP

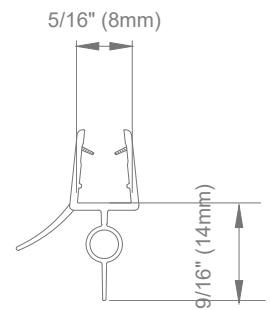

CUSTOM OPTIONS

DIMENSIONS

- 42 in. (1066 mm) - 45 in. (1142 mm) x 96 1/2 in. (2451 mm) height
- Custom sizes and configurations available to fit specific project

GLASS

- 5/16 in. (8 mm) door and hinged fixed panel and 3/8 in. (10mm) clear glass for inline panel
- Clear, Frosted, Reeded, Low iron and others

HARDWARE

- Chrome, brushed stainless, satin gold and satin black hardware finished available.



CH (Chrome)



ST (Brushed Stainless)



SB (Satin Black)



SG (Satin Gold)

GLASS COATINGS

- Nano Fusion - is baked in with lifetime warranty
- Surface Shield - is surface applied with three (3) years of warranty



UNTREATED

TREATED

- Frosted glass made with acid etching process, easy to clean and leaves no finger prints

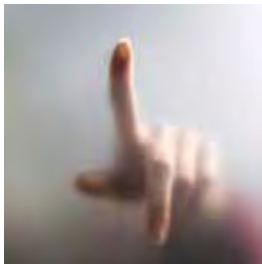

HANDLES

- 6 in. (152mm), 8 in. (203 mm), 12 in. (304 mm), 18 in. (457 mm), 24 in. (609mm) back to back pull

D-SHAPE



METERED



SQUARE METERED



LADDER



- 6 in. x 18 in. (152 x 457 mm) & 6 in. x 24 in. (152 x 609 mm) pull handle and towel bar combination

D-SHAPE



METERED



SQUARE METERED



TOWEL BARS

- 24 in. (609 mm) or smaller towel bar depending on inline panel width

D-SHAPE



METERED



SQUARE METERED



LADDER



ROPE HOOKS

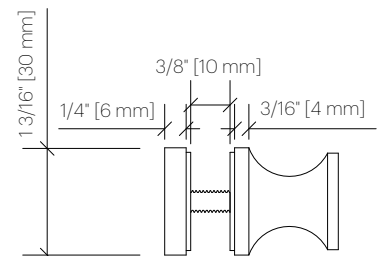

NOTE

- Shower pan with minimum curb width of 2 in. (50 mm) required.
- Opening direction required with optional glass coating or frosted glass.
- Blocking required where fixed panel support arms are installed.